

TEMPERATURE CONTROLLER 0-10VDC 1-2-3 OUTPUTS PROPORTIONAL + INTEGRAL

E13-PT..

Used to monitor the temperature inside buildings, rooms, ducts, tanks, pipes etc and give up to 3 x 0-10vdc output signal linear across the desired proportional band. Suitable to control damper motors, valve actuators, step controllers, relay modules and thyristors etc. Link selectable in various combinations. HTG only, CLG only, HTG+CLG, CLG+CLG, HTG+HTG or HTG+CLG+CLG. These products are also suitable for SUPPLY AIR CONTROL.

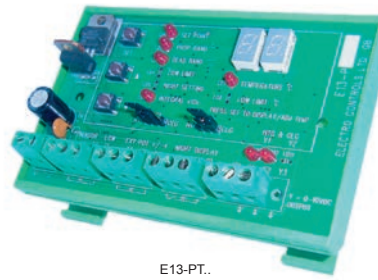

FOR USE WITH THE E10.. RANGE OF NTC SENSORS, REMOTE ADJUSTERS & DISPLAYS - SEE SEPARATE DATA SHEET.

If HTG/CLG links are changed the unit must be reset by turning the power OFF and On. The sensed temperature is indicated via the 2 digit display. The display remains on for approx 5 mins after any adjustments are made and then turns off. It is activated again by pressing the SET button. Power Consumption 2VA

Type	Range C	Prop Band C	Dead Band °C	Integral Time Adj	Supply ± 15%	Output Signal	Function	Mounting	Protection
E13-PT1	-10/+50	0/50	-	0-300s	24VAC/DC	0-10vdc	Htg or Clg	Din Rail	IP00
E13-PT2	-10/+50	0/50	0/10	0-300s	24VAC/DC	2 x 0-10vdc	Htg+Clg, 2 Htg or 2 Clg	Din Rail	IP00
E13-PT3	-10/+50	0/50	0/10	0-300s	24VAC/DC	3 x 0-10vdc	Htg+Clg+Clg	Din Rail	IP00
E13-PT4	25/95	0/50	-	0-300s	24VAC/DC	0-10vdc	Htg or Clg	Din Rail	IP00
OPTIONAL	N = Night Setting adj 0- 40 C Operational Via Time Switch								
ACCESSORIES	EE-M2T	Wall mounting enclosure	125H x 125W x 75D			IP65			

DIMENSIONS

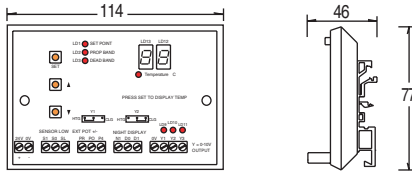

WIRING:

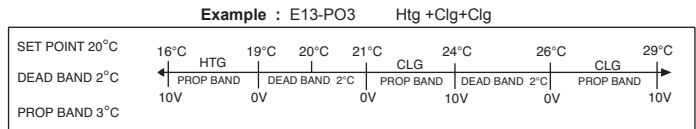
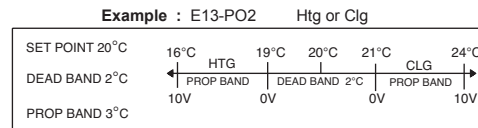
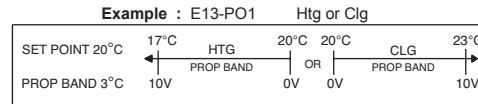
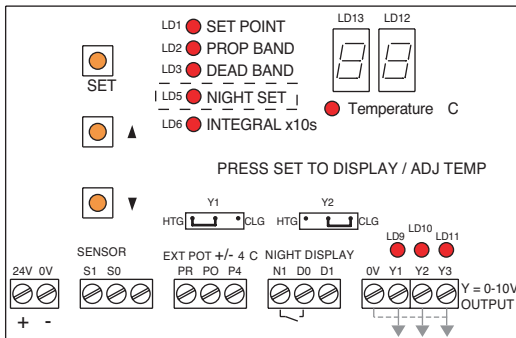

Prop Band and Dead Band are adjustable for each of the outputs on all models.

OUTPUTS:

Use the links to select HTG or CLG output.
 HTG or CLG : Fit Link at Y1 accordingly
 HTG+CLG : Y1 is HTG Y2 is CLG.
 HTG+CLG+CLG : Y1 = HTG Y2+Y3 = CLG

SETTINGS:

These are all of the possible settings, use only the parameters for your application. Pressing the ▲ ▼ buttons allows adjustment during any of the following stages. If the control action is sluggish reduce the prop band or integral time. If it is hunting, increase these settings. If HTG/CLG links are changed, the unit must be reset by turning the power Off and On.

- Press SET Button = Set Point LD1 Lights Adjust to desired setting.
- Press SET Button = Prop Band LD2+Y1 Light Adjust Prop Band for Y1 output.
- Press SET Button = Prop Band LD2+Y2 Light Adjust Prop Band for Y2 output.
- Press SET Button = Prop Band LD2+Y3 Light Adjust Prop Band for Y3 output.
- Press SET Button = Dead Band LD3+Y1+Y2 Light Adjust Dead Band between Y1 and Y2.
- Press SET Button = Dead Band LD3+Y2+Y3 Light Adjust Dead Band between Y2 and Y3.
- Press SET Button = Integral x10s LD6 Lights Adjust Integral Time between 0 and 300 seconds.

OPTIONAL:

Press SET Button = NIGHT SETTING LD5 Lights - Adjust Night Setting. Enabled upon contact closure on terminals N1 - D0. During Night operation the cooling output remains at 0vdc. Pressing the SET Button again restarts the sequence. The unit returns to normal operation if left untouched for 15 seconds.

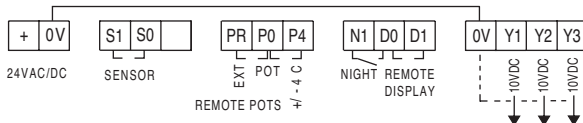

Override - Sensor terminals open: HTG 10vdc CLG 0vdc
 Override - Sensor terminals linked: HTG 0vdc CLG 10vdc

INSTALLATION:

Terminals 0.5-2.5mm Max length 100m. Sensor cable size 7/0.2mm Screened cable is recommended. Keep away from power cables/units which may cause interference. The screen should be earthed at the controller 0V terminal only.